

ZADACI ZA VJEŽBU

1. Prema bazi prizme odredi sam naziv prizme.

a.

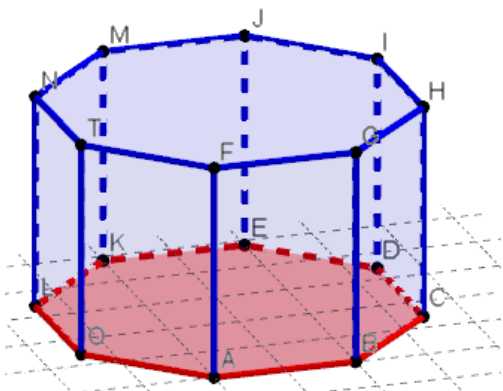

a.

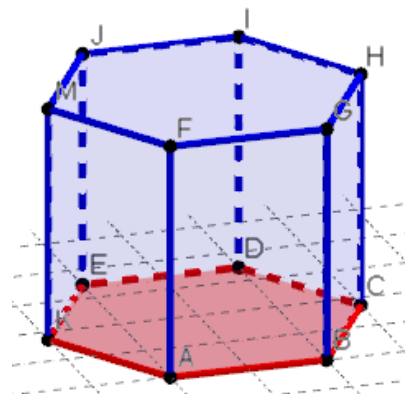

c.

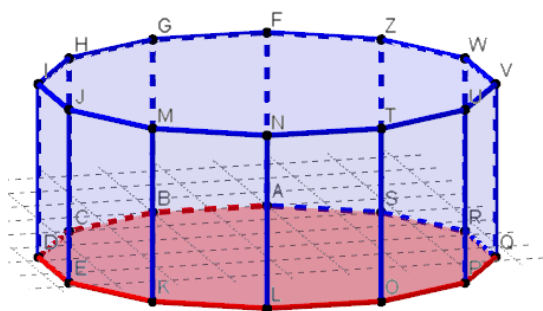

d.

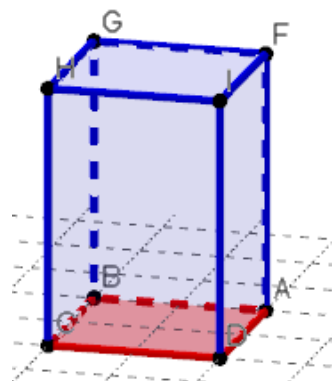

2. Za dane prizme odredi broj strana, bridova i vrhova.

a.

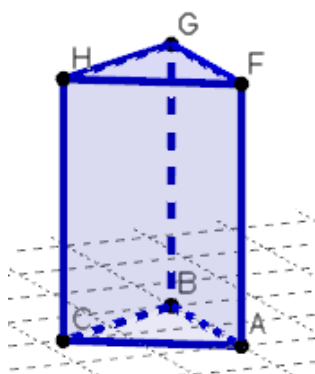

b.

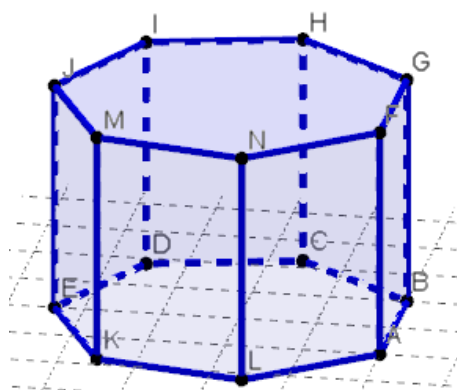

c.

d.

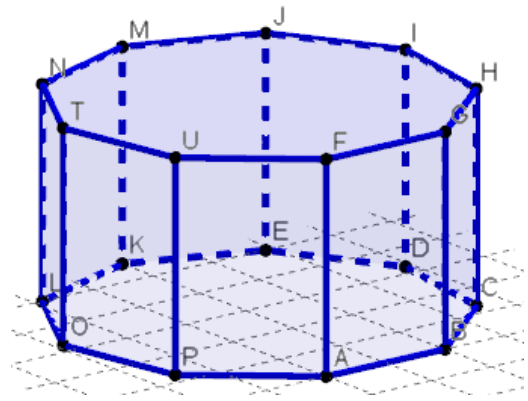
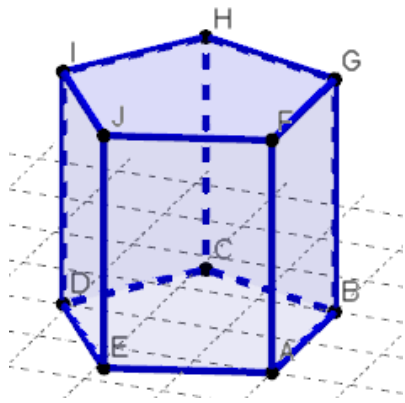

3. Tablicu prepisi u bilježnicu pa popuni

VRSTA PRIZME	BAZA	BROJ STRANA	BROJ VRHOVA
	TROKUT		
		13	
PETNAESTEROSTRANA			
			24